

---

# **CENNIK WEHOPIPE**

**Ważny od 08.12.2005**

Systemy PE ciśnieniowe  
do wodociągów, kanalizacji ciśnieniowej

Tuleje kołnierzowe i redukcje centryczne - ceny od 15.03.2006

A

## **SPIS TREŚCI**

RURY CIŚNIENIOWE PE80 WEHOPIPE .....	A-1
RURY CIŚNIENIOWE PE100 WEHOPIPE .....	A-2
ŁUKI SEGMENTOWE .....	A-3
TRÓJNIKI, TULEJE KOŁNIERZOWE, KOŁNIERZE "DELTAFLX" .....	A-4
REDUKCJE CENTRYCZNE .....	A-5
KOŁNIERZE DOSZCZELNIAJĄCE "FRANK" .....	A-6

# RURY CIŚNIENIOWE PE80 WEHOPIPE

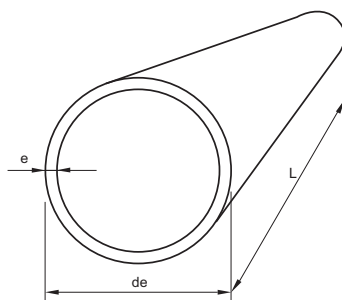

SDR 21 PN 6 (6,3)		
Wymiar		Cena
dn=de	e	zł/m
mm	mm	
40	2,0	3,50
50	2,4	5,18
63	3,0	8,12
75	3,6	11,62
90	4,3	16,80
110	5,3	25,06
125	6,0	32,06
140	6,7	40,18
160	7,7	52,64
180	8,6	66,22
200	9,6	82,04
225	10,8	103,74
250	11,9	126,84
280	13,4	160,16
315	15,0	201,32
355	16,9	255,64
400	19,1	325,92
450	21,5	412,16
500	23,9	508,48
560	26,7	636,44
630	30,0	804,02
710	33,9	*
800	38,1	*
900	42,9	*
1000	47,7	*
1200	57,2	*

SDR 13,6 PN 10		
Wymiar		Cena
dn=de	e	zł/m
mm	mm	
25	2,0	2,10
32	2,4	3,22
40	3,0	5,04
50	3,7	7,70
63	4,7	12,32
75	5,6	17,50
90	6,7	25,06
110	8,1	37,10
125	9,2	47,88
140	10,3	59,92
160	11,8	78,26
180	13,3	99,26
200	14,7	121,80
225	16,6	154,70
250	18,4	190,54
280	20,6	238,70
315	23,2	302,54
355	26,1	383,60
400	29,4	486,36
450	33,1	616,14
500	36,8	760,20
560	41,2	953,82
630	46,3	1205,68
710	52,2	*
800	58,8	*

SDR 11 PN 12,5		
Wymiar		Cena
dn=de	e	zł/m
mm	mm	
25	2,3	2,38
32	2,9	3,92
40	3,7	6,02
50	4,6	9,38
63	5,8	14,84
75	6,8	20,86
90	8,2	30,10
110	10,0	44,66
125	11,4	57,96
140	12,7	72,24
160	14,6	94,92
180	16,4	119,84
200	18,2	147,84
225	20,5	187,18
250	22,7	230,16
280	25,4	288,54
315	28,6	365,26
355	32,2	463,68
400	36,3	588,56
450	40,9	745,36
500	45,4	919,66
560	50,8	1152,20
630	57,2	1459,78
710	64,6	*

długość rur L=12,5m \*\*

- \* ceny rur o średnicach powyżej 630mm podajemy na zapytanie.
- \*\* Standardowo produkujemy rury w odcinkach 12,5 - metrowych, ale na życzenie klienta produkujemy rury dowolnej długości.
- \*\*\* Rury o średnicach 25-110 mm możemy dostarczyć w zwojach.

CENY: loco magazyn w Kleszczowie k/Belchatowa, bez podatku VAT  
Ceny ważne od 08.12.2005. Ceny mogą ulec zmianie.

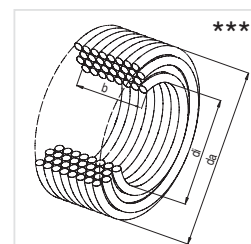

# RURY CIŚNIENIOWE PE100 WEHOPIPE

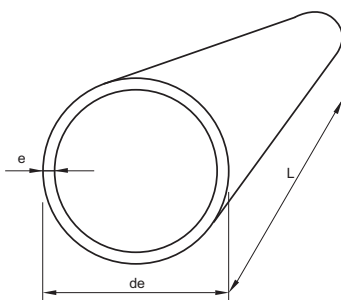

SDR 17 PN10		
Wymiar		Cena zł/m
dn=de mm	e mm	
32	2,0	2,80
40	2,4	4,20
50	3,0	6,44
63	3,8	10,22
75	4,5	14,42
90	5,4	20,58
110	6,6	30,66
125	7,4	39,20
140	8,3	49,14
160	9,5	64,12
180	10,7	81,20
200	11,9	100,24
225	13,4	127,12
250	14,8	155,68
280	16,6	195,58
315	18,7	247,80
355	21,1	315,28
400	23,7	398,44
450	26,7	504,84
500	29,7	623,84
560	33,2	781,48
630	37,4	989,80
710	42,1	*
800	47,4	*
900	53,3	*
1000	59,3	*

SDR 11 PN16		
Wymiar		Cena zł/m
dn=de mm	e mm	
25	2,3	2,38
32	2,9	3,92
40	3,7	6,02
50	4,6	9,38
63	5,8	14,84
75	6,8	20,86
90	8,2	30,10
110	10,0	44,66
125	11,4	57,96
140	12,7	72,24
160	14,6	94,92
180	16,4	119,84
200	18,2	147,84
225	20,5	187,18
250	22,7	230,16
280	25,4	288,54
315	28,6	365,26
355	32,2	463,68
400	36,3	588,56
450	40,9	745,36
500	45,4	919,66
560	50,8	1152,20
630	57,2	1459,78
710	64,6	*

długość rur L=12,5m \*\*

- \* ceny rur o średnicach powyżej 630mm podajemy na zapytanie.
- \*\* Standardowo produkujemy rury w odcinkach 12,5 - metrowych, ale na życzenie klienta produkujemy rury dowolnej długości.
- \*\*\* Rury o średnicach 25-110 mm możemy dostarczyć w zwojach.

CENY: loco magazyn w Kleszczowie k/Bełchatowa, bez podatku VAT  
Ceny ważne od 08.12.2005. Ceny mogą ulec zmianie.

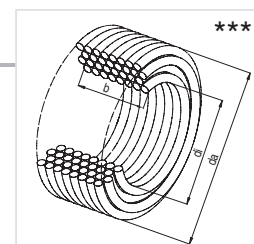

30°

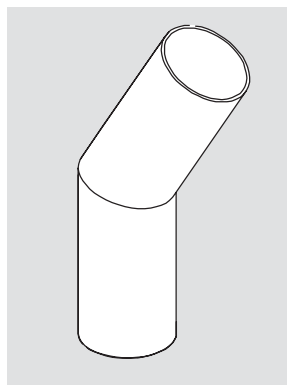

45°

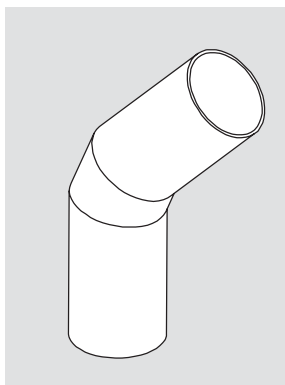

60°

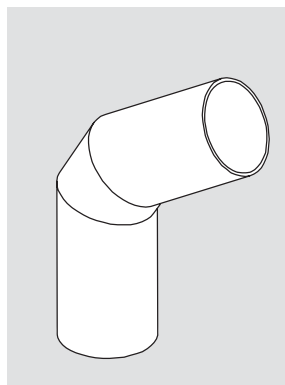

90°

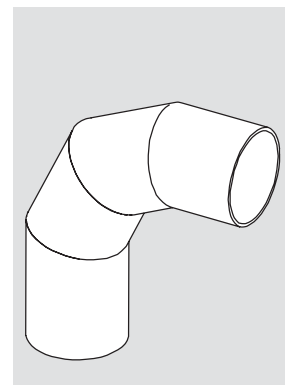

PE100	30 stopni		45 stopni		60 stopni		90 stopni	
	SDR 17	SDR 11	SDR 17	SDR 11	SDR 17	SDR 11	SDR 17	SDR 11
dn=de	Cena	Cena	Cena	Cena	Cena	Cena	Cena	Cena
mm	zł/szt.	zł/szt.	zł/szt.	zł/szt.	zł/szt.	zł/szt.	zł/szt.	zł/szt.
90	26,25	57,50	45,00	60,00	47,50	62,50	67,50	85,00
110	34,50	67,50	57,50	75,00	60,00	80,00	85,00	110,00
125	39,25	75,00	72,50	95,00	75,00	100,00	100,00	130,00
140	57,50	97,50	92,50	120,00	95,00	125,00	135,00	177,50
160	70,00	117,50	115,00	150,00	120,00	157,50	167,50	222,50
180	87,50	137,25	145,00	192,50	152,50	202,50	205,00	267,50
200	106,50	170,00	165,00	220,00	175,00	232,50	247,50	330,00
225	127,50	197,50	190,00	254,75	212,50	288,50	285,00	385,00
250	175,00	267,50	245,00	332,50	268,75	372,50	380,00	520,00
280	210,00	317,50	285,50	392,50	317,50	442,50	445,00	612,50
315	320,00	477,50	430,00	600,00	430,00	600,00	580,00	807,50
355	632,00	936,00	828,00	1 164,00	912,00	1 292,00	1 196,00	1 684,00
400	772,00	1 148,00	996,00	1 416,00	1 108,00	1 580,00	1 444,00	2 048,00
450	960,00	1 420,00	1 224,00	1 748,00	1 504,00	2 156,00	1 908,00	2 724,00
500	1 336,00	1 972,00	1 560,00	2 236,00	1 820,00	2 616,00	2 556,00	3 668,00
560	1 652,00	2 436,00	1 908,00	2 744,00	2 444,00	3 536,00	3 240,00	4 668,00
630	2 316,00	3 408,00	2 748,00	3 976,00	3 152,00	4 568,00	4 524,00	6 556,00
710	*	*	*	*	*	*	*	*
800	*	*	*	*	*	*	*	*
900	*	*	*	*	*	*	*	*
1000	*	*	*	*	*	*	*	*
1200	*	*	*	*	*	*	*	*

\* ceny kształtek o średnicach powyżej 630mm podajemy na zapytanie.

CENY: loco magazyn w Kleszczowie k/Bełchatowa, bez podatku VAT  
Ceny ważne od 08.12.2005. Ceny mogą ulec zmianie.

# TRÓJNIKI, TULEJE KOŁNIERZOWE, KOŁNIERZE „DELTAFLX”

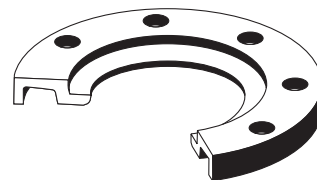
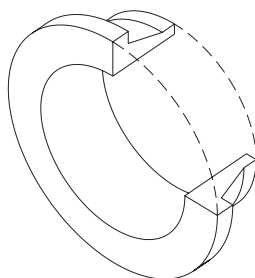
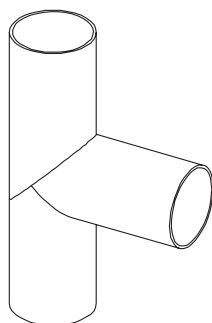

Trójniki segmentowe 90 stopni		
PE100	SDR 17	SDR 11
dn=de	Cena	Cena
mm	zł/szt.	zł/szt.
90	107,50	130,00
110	140,00	167,50
125	160,00	195,00
140	190,00	232,50
160	235,00	307,50
180	277,50	347,50
200	360,00	550,00
225	432,50	565,00
250	512,50	680,00
280	615,00	822,50
315	745,00	1 005,00
355	1 668,00	2 292,00
400	2 132,00	2 984,00
450	2 768,00	3 904,00
500	3 476,00	4 912,00
560	4 384,00	6 232,00
630	5 648,00	8 084,00
710	*	*
800	*	*
900	*	*
1000	*	*
1200	*	*

Tuleje kołnierzowe		
PE100	SDR 17	SDR 11
dn	Cena	Cena
mm	zł/szt.	zł/szt.
90	23,80	26,64
110	30,56	33,04
125	37,04	39,80
140	42,76	46,40
160	52,64	58,76
180	76,72	90,24
200	95,28	98,92
225	107,76	110,36
250	152,48	167,84
280	168,76	182,92
315	204,64	215,40
355	349,72	383,00
400	734,12	790,00
450	866,60	917,68
500	1070,44	1 172,08
560	1 095,40	3 333,98
630	1 305,08	6 538,99
710	*	*
800	*	*
900	*	*
1000	*	*
1200	*	*

Kołnierze DELTAFLEX		
dn	PN 10	PN 16
	Cena	Cena
mm	zł/szt.	zł/szt.
90		39,49
110		44,72
125		46,46
140		54,59
160		67,36
180		67,36
200	90,59	103,37
225	90,59	103,37
250	137,05	170,15
280	137,05	170,15
315	170,15	217,19
355	292,68	382,82
400	368,18	441,35
450	528,46	
500	528,46	
560	929,15	
630	720,09	
710	*	
800	*	
900	*	
1000	*	
1200	*	

\* ceny kształtek o średnicach powyżej 630mm podajemy na zapytanie.

CENY: loco magazyn w Kleszczowie k/Bełchatowa, bez podatku VAT  
Ceny ważne od 15.03.2006. Ceny mogą ulec zmianie.

# REDUKCJE CENTRYCZNE

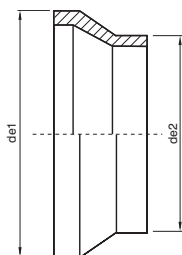

PE100		SDR 17	SDR 11
de1	de2	Cena	Cena
mm	mm	zł/szt.	zł/szt.
90	50	22,24	22,24
90	63	22,24	22,24
90	75	22,24	22,24
110	50	27,68	27,68
110	63	27,68	27,68
110	75	27,68	27,68
110	90	27,68	27,68
125	63	35,76	35,76
125	75	35,76	35,76
125	90	35,76	35,76
125	110	35,76	35,76
140	75	43,68	43,68
140	90	43,68	43,68
140	110	43,68	43,68
140	125	43,68	43,68
160	90	50,56	50,56
160	110	50,56	50,56
160	125	50,56	50,56
160	140	50,56	50,56
180	90	76,20	76,20
180	110	76,20	76,20
180	125	72,28	72,28
180	140	69,44	69,44
180	160	69,44	69,44
200	140	221,52	221,52
200	160	172,00	172,00
200	180	153,00	153,00
225	140	251,04	256,76
225	160	215,56	219,96
225	180	204,76	209,84
225	200	180,44	185,12
250	160	286,28	294,32
250	180	265,60	272,24
250	200	243,88	250,24
250	225	232,04	237,76
280	200	318,88	327,36

PE100		SDR 17	SDR 11
de1	de2	Cena	Cena
mm	mm	zł/szt.	zł/szt.
280	225	298,24	306,28
280	250	286,28	293,92
315	200	407,96	418,36
315	225	346,20	355,56
315	250	328,00	336,84
315	280	307,60	315,40
355	225	1 468,70	1 423,97
355	250	1 332,29	1 365,02
355	280	1 237,06	1 268,78
355	315	1 197,50	1 229,57
400	225	4 808,50	5 520,96
400	250	4 510,75	4 661,09
400	280	4 000,75	4 000,75
400	315	3 332,98	3 794,35
400	355	2 230,75	2 705,42
450	280	5 719,92	5 719,92
450	315	5 078,06	5 078,06
450	355	4 244,40	4 450,13
450	400	2 851,54	3 641,42
500	315	6 980,26	6 980,26
500	355	6 101,23	6 679,58
500	400	5 178,48	5 579,28
500	450	4 611,17	5 054,40
560	400	8 172,91	8 732,78
560	450	5 096,83	5 319,74
560	500	4 163,42	4 542,82
630	400	10 128,24	10 661,57
630	450	8 491,06	8 914,56
630	500	6 246,38	6631,63
630	560	5 181,74	5 438,69
710	500	*	*
710	560	*	*
710	630	*	*
800	560	*	*
800	630	*	*
800	710	*	*

\* ceny kształtek o średnicach powyżej 630mm podajemy na zapytanie.  
 CENY: loco magazyn w Kleszczowie k/Belchatowa, bez podatku VAT  
 Ceny ważne od 15.03.2006. Ceny mogą ulec zmianie.

# KOŁNIERZE DOSZCZELNIAJACE „FRANK”

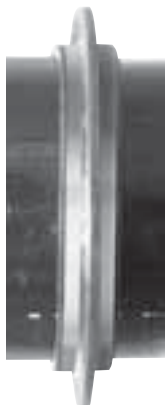

dn=90 ÷ 315 mm



dn=355 ÷ 1200 mm

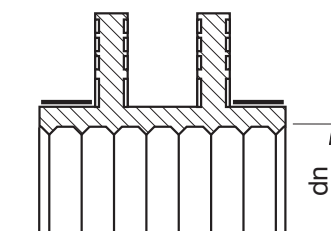
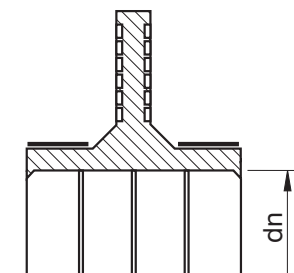

Kołnierze „FRANK”	
dn	Cena
mm	zł/szt.
90	131,12
110	137,33
125	138,36
140	138,69
160	148,27
180	220,97
200	230,76
225	234,19
250	244,09
280	262,58
315	275,02

Kołnierze „FRANK”	
dn	Cena
mm	zł/szt.
355	410,78
400	448,77
450	481,46
500	513,27
560	556,52
630	710,62
710	*
800	*
900	*
1000	*
1200	*

\* ceny kształtek o średnicach powyżej 630mm podajemy na zapytanie.  
CENY: loco magazyn w Kleszczowie k/Bełchatowa, bez podatku VAT  
Ceny ważne od 08.12.2005. Ceny mogą ulec zmianie.

# Pipe Specialist

50-letnie doświadczenie w produkcji rur

